

P02 | 氧化鋯陶瓷軸承
ZrO₂ Ceramic Bearing For Industry

P03 | 碳化矽陶瓷軸承
SiC Ceramic Bearing For Industry

P04 | PEEK樹脂軸承
PEEK Plastic Bearing

P05 | 不鏽鋼陶瓷混合軸承
Stainless Steel Ceramic Hybrid Bearing

P06 | 高級自行車用陶瓷軸承
Ceramic Hybrid Bearing For Bicycle

P07 | 直排輪，滑板陶瓷混合軸承
Ceramic Bearing for Roller Skater, Skateboard

P08 | 陶瓷球
Ceramic Ball

P10 | 材料特性表
Material Property

P11 | 金屬滾珠軸承規範說明
Metal Ball Bearing Specification

P12 | 軸承規格尺寸
Ceramic Bearing Size

P14 | 陶瓷球規格尺寸
Ceramic Ball Size& Stock





CF Series

內外環	Rings	ZrO2 Ceramic
保持器	Retainer	PEEK Resin
滾珠	Ball	ZrO2;Si3N4 Ball
產品料號	P/N	CF□□□□KZ

氧化鋯陶瓷軸承 ZrO2 Ceramic Bearing For Industry

產品特色 Product Feature

在腐蝕環境中比不鏽鋼軸承壽命更長
Excellent chemical resistance than stainless steel bearing.

不加潤滑油脂，避免無塵環境中污染
No grease contamination concern in clean room application.

良好的耐腐蝕特性，在大部份酸鹼和溶劑環境中都可使用
Good corrosion resistance at most acid& alkaline environment.

強力型PEEK保持器使用壽命更長久
Power type PEEK retainer to extend bearing life.

無磁性，絕緣
Non-magnetism,insulation.

應用場合 Application

- 半導體濕式設備..... Semiconductor wet equipment
- LCD 濕式設備..... LCD wet equipment
- 食品機械設備..... Food equipment
- 電鍍設備..... Plating equipment
- 化工設備..... Chemical process equipment

使用注意事項 Operation Note

陶瓷軸承公差配合時，以間隙配合為宜
Recommend loose clearance for ceramic bearing installation fit.

軸承裝置時，請勿以榔頭敲打，避免破裂
Don,t strike the bearing when installing the bearing to shaft or bearing house.

若使用環境有強酸，建議請先與我們討論使用狀況
Discuss for chemical compatibility when used on strong acid chemical environment.

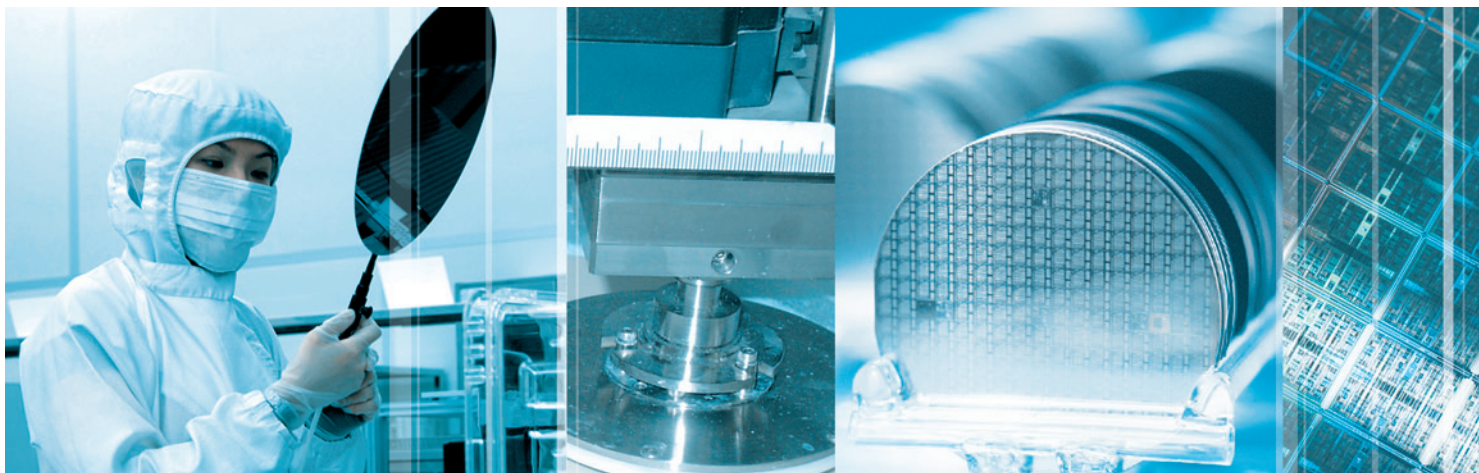

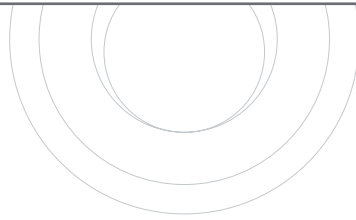

碳化矽陶瓷軸承 SiC Ceramic Bearing For Industry

產品特色 Product Feature

耐腐蝕性比其他陶瓷材料佳
Excellent chemical resistance than other ceramic material.

耐高溫&高熱傳導率
High temperature resistance & High thermal conductivity.

硬度高，低摩擦係數
Excellent hardness and wear resistance.

應用場合 Application

滾珠軸承用於強酸輸送環境
Ball bearing for strong acid chemical conveyor system.

PUMP 內軸承套件
Bearing bushes for Pump

陶瓷材質耐化性比較 Chemical compatibility for different ceramic material

材質 Material 化學類型 Chemical Type	陶瓷材質 Ceramic Material			不鏽鋼
	氧化鋯 ZrO2	氮化矽 Si3N4	碳化矽 SiC	SUS440C
弱酸 Weak Acid	○	○	◎	X
強酸 Strong Acid	○	△→○	◎	X
鹼 Alkali	○	○	◎	△
高濕 Humid	◎	○	◎	△
價格 Cost	Middle	High	High	Low

◎Excellent ○Good △Application Limited X Not Recommend



SC Series

內 外 環	Rings	Silicon Carbide (SiC)
保 持 器	Retainer	Teflon Resin
滾 珠	Ball	Silicon carbide (SiC)
產品料號	P/N	SC□□□□KC





PEEK樹脂軸承 PEEK Plastic Bearing

產品特色 *Product Feature*

PEEK 材質耐溫性佳，連續使用溫度可達 260°C
PEEK material has higher temperature resistance up to 260°C

在水,酸,鹼化學品環境有良好的耐化性
Excellent corrosion resistance at most chemical environment.

機械強度佳，材質尺寸穩定性良好
Excellent dimension stability & mechanical strength.

PEEK 材質通過食品工業FDA認證
FDA approval for food application industry.

PK Series

內外環	Rings	PEEK Resin
保持器	Retainer	PEEK Resin
滾珠	Ball	ZrO ₂ ; Si ₃ N ₄ ; SiC Ball

產品料號 *Product No*



應用場合 *Application*

半導體濕式設備..... Semiconductor wet equipment

LCD蝕刻設備..... LCD wet equipment

太陽能濕式設備..... Solar Cell wet equipment

電鍍設備..... Plating equipment

食品機械..... Food machine

使用注意事項 *Operation Note*

PEEK 軸承的內外徑公差與內部游隙與一般標準軸承不同，內徑公差0~+0.1mm,外徑公差0~-0.1mm

Tolerances for ID, OD and internal clearance for PEEK bearing are different from standard bearing, ID Tolerance 0~+0.1mm, OD Tolerance 0~-0.1mm

在強酸下使用條件時，請先討論其適用性

Discuss for chemical compatibility when used on strong acid chemical environment.

樹脂軸承會隨著輸送速度增快而影響壽命

Plastic bearing life will reduce by faster conveyor speed.

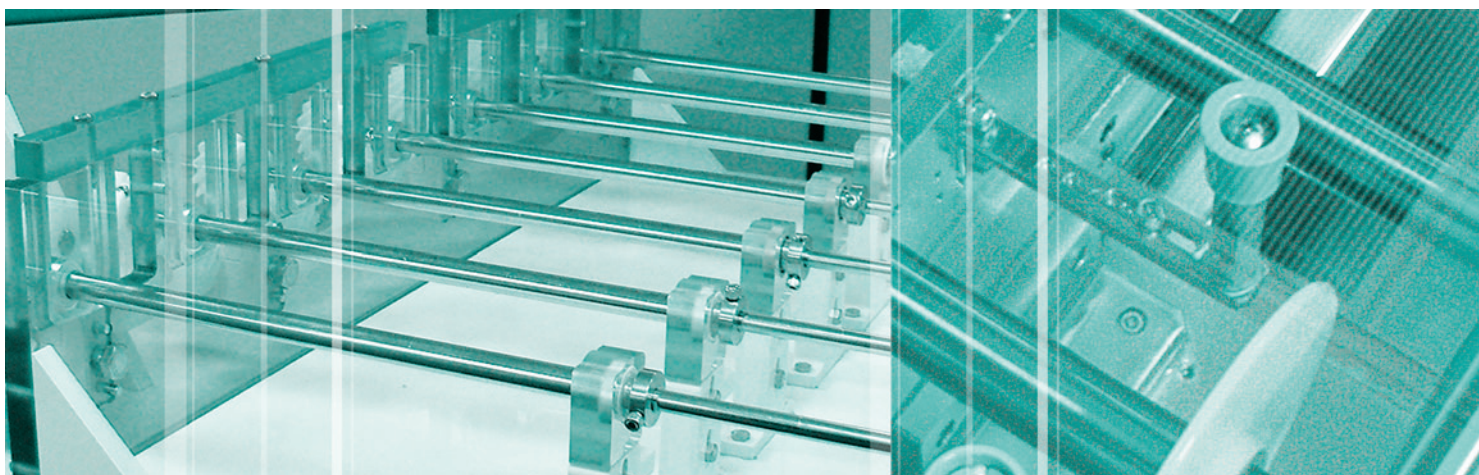

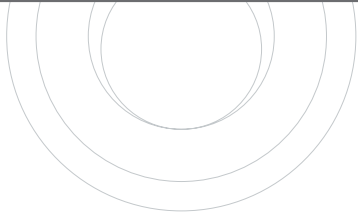

不鏽鋼陶瓷混合軸承 Stainless Steel Ceramic Hybrid Bearing

產品特色 *Product Feature*

440C不鏽鋼內外環比軸承鋼不易生鏽
Stainless Steel material rings have good corrosive resistance than chrome steel material.

適用於真空及高溫環境
Suitable for vacuum and high temperature application.

G5等級氮化矽(Si3N4)陶瓷球熱膨脹係數小，重量輕，運轉更順暢
Grade 5 silicon nitride ball have good running performance than steel ball.

低轉速下可以不加油脂運轉，減少製程污染機會
No grease needed to reduce contamination issues at lower speed condition.

應用場合 *Application*

LCD UV/IR 高溫設備，風刀輸送機構
LCD UV/IR high temperature conveyor, A/K conveyor.

半導體設備，太陽能生產設備
Semiconductor equipment, Solar cell equipment.

窯爐高溫設備
High temperature application equipment.

使用注意事項 *Operation Note*

在沒有潤滑狀況下，不建議用於高轉速
Don't recommend higher conveyor speed on greaseless situation.

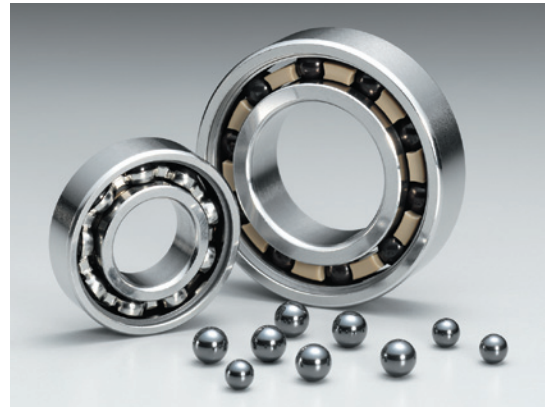

SHB Series

內 外 環	Rings	Stainless Steel 440C
保 持 器	Retainer	Stainless Steel
滾 珠	Ball	Si3N4 Ball
產品料號	P/N	SHB□□□□-□S-C4

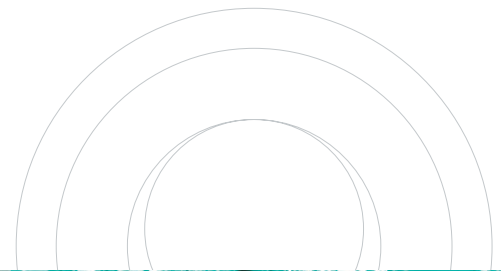



高級自行車用陶瓷軸承 Ceramic Hybrid Bearing For Bicycle

SRC Series

產品特色 Product Feature

G5等級氮化矽陶瓷球，重量僅為金屬球的40%
Grade 5 super high roundness silicon nitride ceramic ball, weight 40% of steel ball.

內含低阻力 Kluber NB52，潤滑油脂
Low torque grease Kluber NB52.

非接觸式塑膠封蓋，減少軸承運轉阻力
Non-contact rubber seal to reduce friction.

應用場合 Application

前後花鼓軸承..... Front & Rear hubs,
Bottom Bracket軸承..... Bottom Bracket B.B
頭碗軸承..... Head sets
踏板..... Pedal pivot axel
變速器導輪..... Chain tensioner pulley

花鼓內滾珠規格比較 Comparison of Hub Ball Specification

Material	Steel Ball	Si3N4 Ball
Ball Grade	Grade 20~	Grade 5
Density(g/cm ³)	7.6	3.2
Max.Surface Roughness (Ra.µm)	0.04	0.014
Allowable Deviation from Spherical form (µm)	0.5	0.13
Hardness, HV	700~ 800	1400~1700

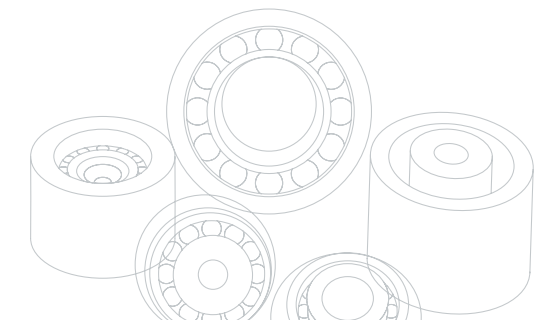

直排輪，滑板陶瓷混合軸承 Ceramic Bearing for Roller Skater, Skateboard

SRS Series

SPEED ROLLER SKATER BEARING

直排輪及滑板軸承需要的是運轉速度，順暢及穩定。陶瓷混合軸承採用輕量化氮化矽陶瓷球，及ABEC-5精度設計，必定能滿足直排輪及滑板愛好者的需求!

Roller skater and skateboard need smoother, acceleration faster and stability.

SRS Series Ceramic Hybrid Bearing come with lightweight G5 grade silicon nitride ball and ABEC-5 precision, it can fully satisfy skater needed!

產品特色 Product Feature

Si3N4輕量化陶瓷球，重量輕，增圓度佳
Silicon nitride lightweight ceramic ball weight 40% of steel ball.

ABEC-5 的軸承精度，運轉表現佳，可以維持運轉穩定，滑順及高速競賽運轉

ABEC-5 bearing precision makes running durability and smoother.

非接觸式封蓋，減少磨擦，清洗容易
Non-contact seals for easy cleaning & low friction.

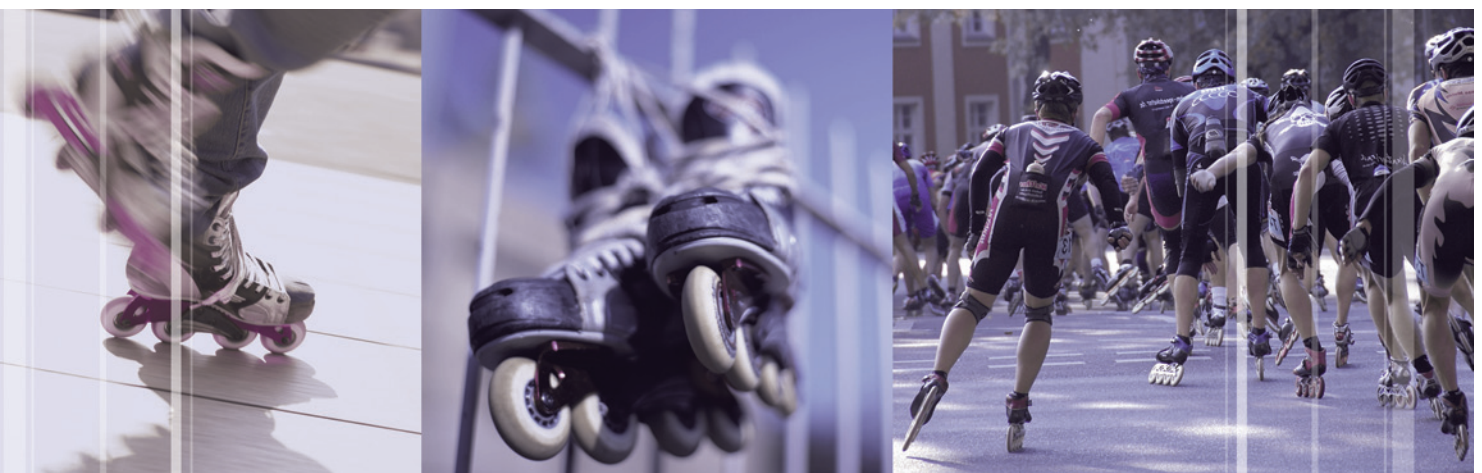



陶瓷球 Ceramic Ball

Ceramic Ball Series

陶瓷球比金屬鋼球有許多優異的特性，因此使用於高速運轉，化學惡劣環境，真空，高溫或絕緣環境中，可以提高軸承的使用壽命及性能。

Ceramic Ball have many advantages comparing with Steel Ball, the bearing come with ceramic ball can increase bearings performance and extend bearing life when used on High speed, Chemical, Vacuum and High temperature environment.

產品特色 Product Feature

耐化性佳: 陶瓷球可耐大部份的化學品腐蝕
Good corrosion resistance.

重量輕: Si3N4陶瓷球是鋼珠的40%重量
Si3N4 ball only 40% weight of steel ball..

硬度高: Si3N4陶瓷球的硬度比鋼珠高一倍
Better hardness than steel ball.

熱膨脹係數: Si3N4陶瓷球是鋼珠的1/4
Lower thermal expansion than steel ball.

耐高溫: Si3N4 陶瓷球可以在800°C時仍維持其機械特性
Excellent mechanical property even at 800°C temperature.

陶瓷球增圓度佳，磨擦係數小
Better ball geometry & surface finish.

在低油脂狀況下可以高速運轉
Work in low lubrication condition.

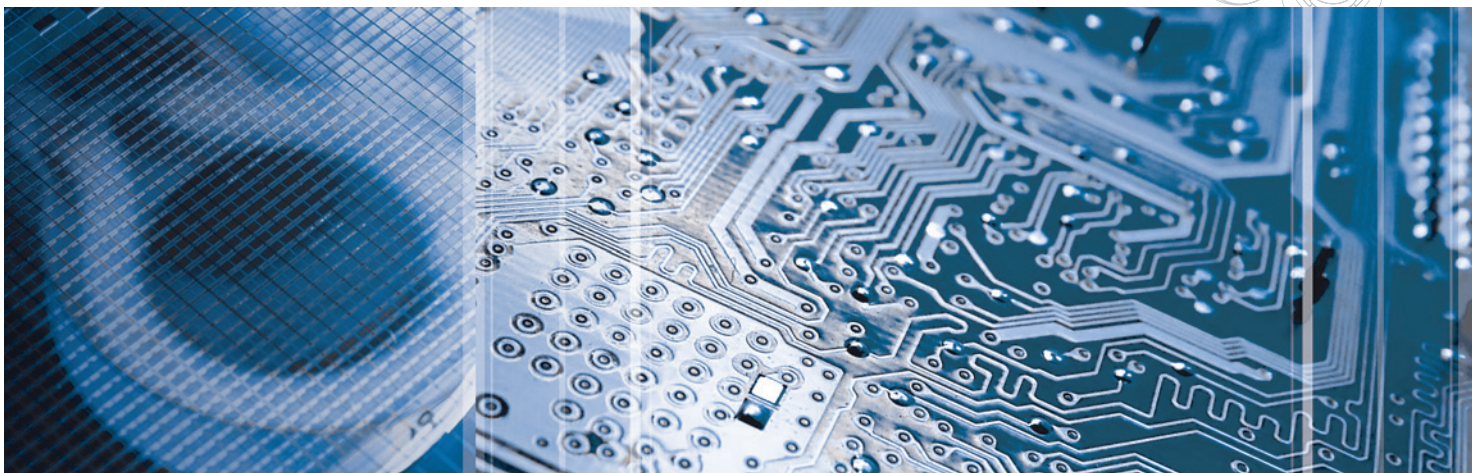

Al₂O₃ 氧化鋁 球圖



Product:	Al ₂ O ₃ Ball
Density:	3.93 g/cm
Color:	Ivory
Grade:	G28~G100
Ball Size Available:	1.00~50.80mm

ZrO₂ 氧化鋯 球圖



Product:	ZrO ₂ Ball
Density:	6.0 g/cm
Color:	White
Grade:	G10
Ball Size Available:	0.80~25.40mm

Si₃N₄ 氮化矽 球圖



Product:	Si ₃ N ₄ Ball
Density:	3.2 g/cm
Color:	Black
Grade:	G5
Ball Size Available:	0.80~76.20mm

SiC 碳化矽 球圖



Product:	SiC Ball
Density:	3.15 g/cm
Color:	Black
Grade:	G10~G16
Ball Size Available:	1.00~19.05mm

陶瓷球製程



陶瓷球等級區分 Ceramic Ball Grade

等級 Grade	球直徑允許變動量 Ball Dia Variation VDWS(um)	可允許球形誤差 Allowable Deviation From Deviation From Spherical Form(um)	最大表面粗糙度 Surface Roughness (um)	批直徑允許變動量 Lot Dia. Variation(VDWL,um)
G5	0.13	0.13	0.014	0.25
G10	0.25	0.25	0.02	0.5
G16	0.4	0.4	0.032	0.8
G20	0.5	0.5	0.04	1



材料特性表 Material Property

金屬材料的特性 *Property of Metal Material*

金屬材料 Metal Material	線膨脹係數 X10 ^{°C}	縱彈性係數 Gpa	硬度 HV	比透磁率	耐腐蝕性
軸承鋼SUJ2	12.5	208	700~800	強磁性	X
不鏽鋼SUS440C	10.1	200	670	1.04以下	△
不鏽鋼 SUS304C	16.3	193	160	1.04以下	○
不鏽鋼SUS316	16	193	220	1.04以下	○
不鏽鋼SUS630	10.8	200	290~380	強磁性	○

陶瓷材料的特性 *Property of Ceramic Material*

特 性 Property	單位Unit	軸承鋼SUJ2	氧化鋁Al ₂ O ₃	氧化鋯 ZrO ₂	氮化矽Si ₃ N ₄	碳化矽SiC
密 度 Density	g/cm ³	7.6	3.93	6	3.2	3.15
硬 度 Hardness	HV	700~800	1500~1650	1100~1300	1400~1700	2000~2500
抗彎強度 Bending Strength	Mpa	2400	300~600	1000~1500	600~1000	450~800
斷裂韌性 Fracture Toughness	Mpa • m ^{1/2}	15	3.5	11	7	4~5
熱膨脹係數 Coff. of Thermal Expansion	X10 ⁻⁶ °K	12.5	8	10.5	3.2	4.3
熱傳導 Thermal conductivity	W/M,K	30~40	20~30	3	30	60
耐溫性 Temp. Resistance	°C	180	1700	1000	1500	2000
磁 性 Magnetism	-	YES	No	No	No	No
耐腐蝕性 Anti-Corrosion	-	Poor	Good	Good	Good	Excellent

工程塑膠的特性 *Property of Engineering Plastic*

材 料 Material	單位Unit	PP	PE	PTFE	POM	PPS	PEEK
密 度 Density	g/cm ³	0.91	0.94	2.18	1.41	1.35	1.32
硬 度 Hardness	Rockwell	70~75	65~70	55	80	84	90
最高使用溫度 Max. Operation Temperature	°C	90	80	200	100	230	260
線膨脹係數 Coff. of Linear Expansion	X10 ⁻⁵ / K	17	20	12	10	5	5
摩 擦 係 數 Coff. of Friction(μ)	ρ=0.05N/mm ² v=0.6m/s	0.3	0.29	0.1	0.32	-	0.3
耐腐蝕性Anti-Corrosion	-	○	○	◎	△	○	◎

◎ Excellent ○ Good △ Application Limited

※ 以上資料僅供參考

About data only for reference only.

金屬滾珠軸承規範說明 Metal Ball Bearing Specification

滾珠軸承精度等級 Tolerance Classes

ISO492	Normal	Class 6	Class 5	Class 4	Class 2
JIS	CLASS 0	Class 6	Class 5	Class 4	Class 2
DIN	P0	P6	P5	P4	P2
AFBN	ABEC-1	ABEC-3	ABEC-5	ABEC-7	ABEC-9

滾珠軸承內環尺寸精度 Inner Ring Tolerance

內徑		內徑平均公差 $\Delta dmp, \mu m$									
d, mm		Normal		Class 6		Class 5		Class 4		Class 2	
Over	To	Min.	Max.	Min.	Max.	Min.	Max.	Min.	Max.	Min.	Max.
2.5	10	0	-8	0	-7	0	-5	0	-4	0	-2.5
10	18	0	-8	0	-7	0	-5	0	-4	0	-2.5
18	30	0	-10	0	-7	0	-6	0	-5	0	-2.5
30	50	0	-12	0	-10	0	-8	0	-6	0	-2.5

滾珠軸承外環尺寸精度 Outer Ring Tolerance

外徑		外徑平均公差 $\Delta Dmp, \mu m$									
D, mm		Normal		Class 6		Class 5		Class 4		Class 2	
Over	To	Min.	Max.	Min.	Max.	Min.	Max.	Min.	Max.	Min.	Max.
6	18	0	-8	0	-7	0	-5	0	-4	0	-2.5
18	30	0	-9	0	-8	0	-6	0	-5	0	-4
30	50	0	-11	0	-9	0	-7	0	-6	0	-4
50	80	0	-13	0	-11	0	-9	0	-7	0	-4

軸承游隙說明 Ball Bearing Internal clearance 徑向游隙 Radial Internal Clearance

Unit: μm

Bore dia. d, mm		C2		Cn		C3		C4		C5	
Over	To	Min.	Max.	Min.	Max.	Min.	Max.	Min.	Max.	Min.	Max.
6	10	0	7	2	13	8	23	14	29	20	37
10	18	0	9	3	18	11	25	18	33	25	45
18	24	0	10	5	20	13	28	20	36	28	48
24	30	1	11	5	20	13	28	23	41	30	53
30	40	1	11	6	20	15	33	28	46	40	64
40	50	1	11	6	23	18	36	30	51	45	73

※ 以上資料為金屬滾珠軸承規範參考表

Above information are the metal ball bearing specification for reference.

軸承規格尺寸 Ceramic Bearing Size

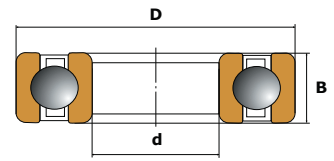

Bearing No	Dimension, mm			CF series	SC Series	PK series	SHB series	SS Series
	d(内徑)	D(外徑)	B(厚度)					
684	4	9	4					
694	4	11	4					
604	4	12	4					
624	4	13	5					
634	4	16	5	○				
685	5	11	5					
695	5	13	4			●		
605	5	14	5	●		●		
625	5	16	5	○		●		
635	5	19	6	●		●		
686	6	13	3.5 / 5	○				
696	6	15	5					
606	6	17	6	●		●		
626	6	19	6	●				
636	6	22	7					
687	7	14	5					
697	7	17	5					
607	7	19	6	○		○		
627	7	22	7					
637	7	26	9					
688	8	16	5				○	
698	8	19	6	●				
608	8	22	7	●	○	●	●	
628	8	24	8	●				
638	8	28	9					
689	9	17	5	●			○	
699	9	20	6				○	●
609	9	24	7	●				
629	9	26	8	●				
639	9	30	10					
R6	9.525	22.225	7.142	●	○		○	
6800	10	19	5	●		●	●	
6900	10	22	6	●		●	●	●
6000	10	26	8	●	●	●	●	●
6200	10	30	9	●	○	●	○	
6801	12	21	5	●		●	●	
6901	12	24	6	●		●	○	●
6001	12	28	8	●	●	●	●	●
6201	12	32	10	●		●	●	

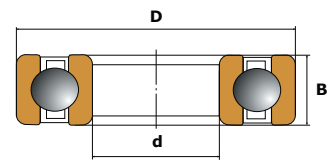

Bearing No	Dimension, mm			CF series	SC Series	PK series	SHB series	SS Series
	d(内径)	D(外径)	B(厚度)					
6802	15	24	5	●		●		●
6902	15	28	7	●		●		●
6002	15	32	9	●	●	●	●	●
6202	15	35	11	●		●		
6803	17	26	5	●				
6903	17	30	7	●		●		●
6003	17	35	10	●	●	●	●	●
6203	17	40	12	●				
6804	20	32	7	●		●		●
6904	20	37	9	●		●	●	●
6004	20	42	12	●	●	●	●	●
6204	20	47	14	●		●	●	●
6805	25	37	7	●			○	●
6905	25	42	9	●		●		
6005	25	47	12	●	●	●	●	
6205	25	52	15	●		●		
6806	30	42	7			●		
6906	30	47	9			●		
6006	30	55	13	●	●	●	●	
6206	30	62	16	●				
6908	40	62	12	○		●		
6008	40	68	15	●		●		
6208	40	80	18					
6009	45	75	16	●				
7000	10	26	8	●		●		
7001	12	28	8	○				
7002	15	32	9	●				
7003	17	35	10	○				
7904	20	37	9	●		●		
7004	20	42	12	●		●		
7005	25	47	12	●				
7008	40	68	15	○				
1200	10	30	9	●				
1201	12	32	10	●				
1202	15	35	11	●				
1203	17	40	12	●				
1204	20	47	14	●				
1205	25	52	15	●				
2205	25	52	18	●				

●兩周内交期

○ 4~6 WEEKS 交期

空格-表示討論後生產

●Delivery within two weeks

○ Delivery around 4~6 weeks

Blank Space-Suggest discuss with us

陶瓷球規格尺寸 Ceramic Ball Size & Stock

Ball Dimension		Si3N4/氮化矽	ZrO2/氧化鋯	Al2O3/氧化鋁	SiC/碳化矽
mm	Inch				
Φ0.800		●	●		
Φ1.000		●	●	●	●
Φ2.000		●	●	●	●
Φ2.381	3/32	●	●	●	●
Φ2.500		●	●	●	●
Φ2.778	7/64	●	●	●	●
Φ3.000		●	●	●	●
Φ3.175	1/8	●	●	●	●
Φ3.500		●	●	●	●
Φ3.969	5/32	●	●	●	●
Φ4.000		●	●	●	●
Φ4.500		●	●	●	●
Φ4.763	3/16	●	●	●	●
Φ5.000		●	●	●	●
Φ5.556	7/32	●	●	●	●
Φ5.953	15/64	●	●	●	●
Φ6.000		●	●	●	●
Φ6.350	1/4	●	●	●	●
Φ6.747	17/64	●	●	●	●
Φ7.000		●	●	●	●
Φ7.144	9/32	●	●	●	●
Φ7.500		●	●	●	●
Φ7.938	5/16	●	●	●	●
Φ7.980		●	●	●	●
Φ8.000		●	●	●	●
Φ8.500		●	●	●	●
Φ8.731	11/32	●	●	●	●
Φ9.000		●	●	●	●
Φ9.525	3/8	●	●	●	●
Φ10.000		●	●	●	●
Φ12.000		●	●	●	●
Φ19.050		●	●	●	●
Φ25.400		●	●	●	
Φ50.800		●		●	
Φ76.200		●			

我們也提供小於1mm 及大於10mm 的陶瓷球。

Other Ball size less than 1mm, or over 10 mm also stock available.

- : 表示備有庫存項目. 若沒有庫存項目交期約30 天
- : Stock item. Other non-stock items delivery within 30 days.

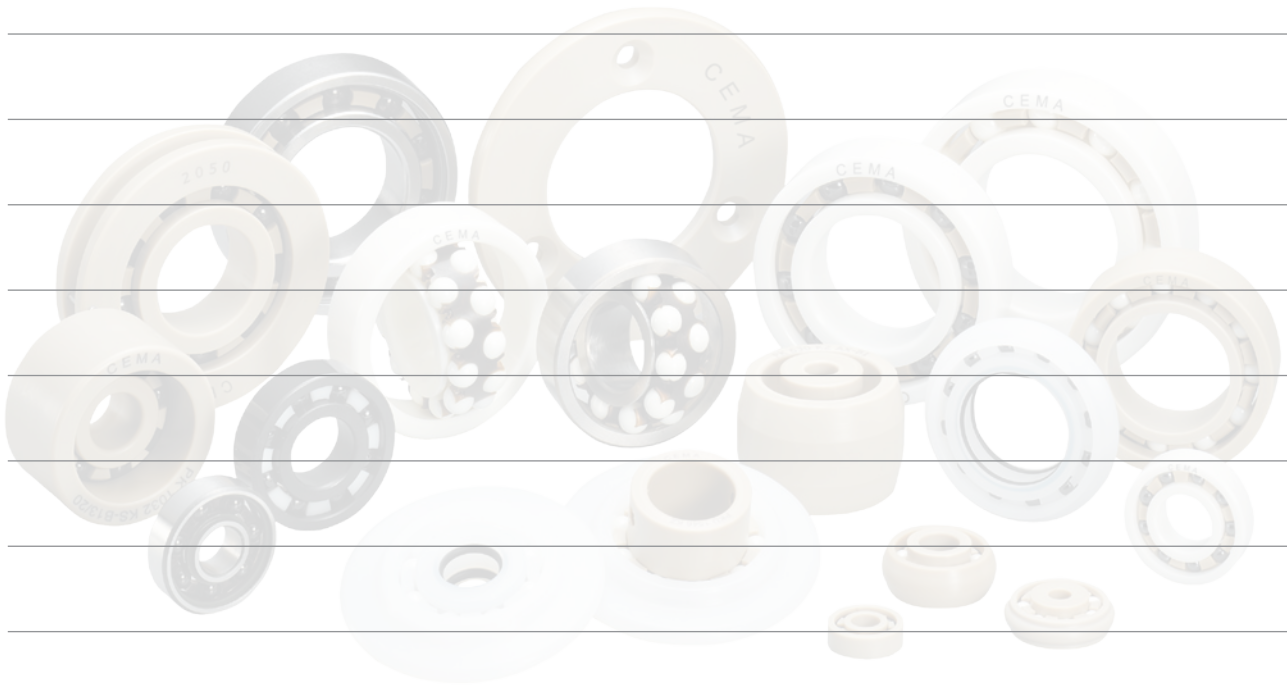

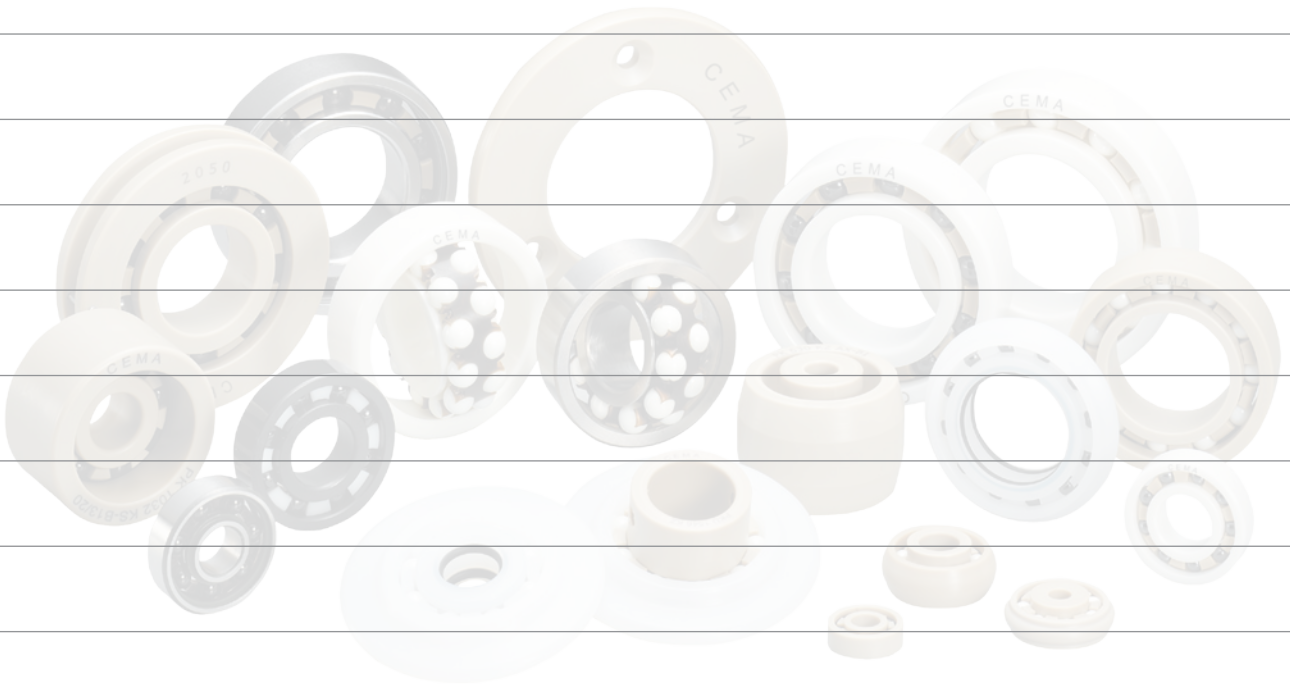



南宜國際材料有限公司 SinMat Technology Corporation

TAIWAN

新竹 Hsinchu

地址: 30288新竹縣竹北市台元科技園區台元一街8號6F-1

Address: 6F.-1, No.8, Taiyuan 1st St., Zhubei City, Hsinchu County
30288, Taiwan

TEL: 886-3-560-1270 FAX: 886-3-560-1290

台南 Tainan

地址: 74442台南市新市區國際路13號6F-619室

Address: 6F.-619, No.13, Guoji Rd., Xinshi Dist., Tainan City
74442, Taiwan

TEL: 886-6-599-2080 FAX: 886-6-599-2090

昆山南宜喜瑪商貿有限公司 KunShan CEMA Technology Corporation Ltd.

CHINA

昆山 KunShan

地址: 215301江蘇省昆山市開發區偉業路18號現代廣場A座1713室

Address: Room1713, Modern Plaza Tower A, No.18, WeiYe Rd., Development Zone, KunShan City, JiangSu 215301 China

TEL: 86-512-8616-0620 FAX: 86-512-8616-0621

E-mail: service@cemabearing.com

Http://www.cemabearing.com